

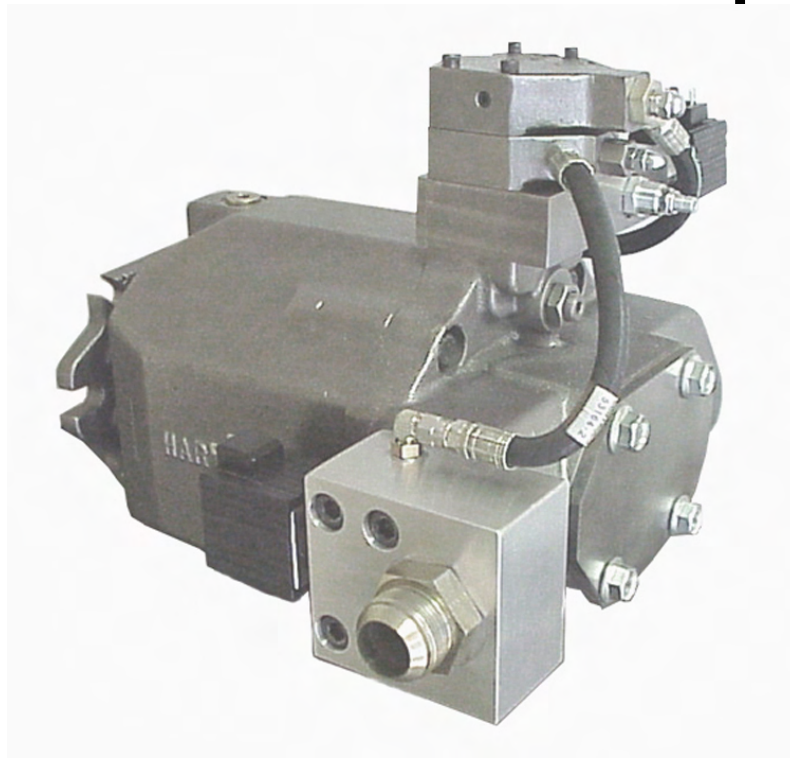

HC, Hand-Knob Adjusted Pressure Compensator for PVX Series Pumps

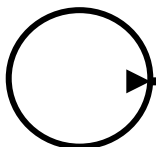

*Hydraulic pumps & motors with a **hart of gold**™*



**604 PROGRESS DRIVE, HARTLAND, WI 53029
USA**

Phone: (262) 367-4299

URL: www.hartmanncontrols.com

FAX: (262) 367-5645

E-mail: sales@hartmanncontrols.com

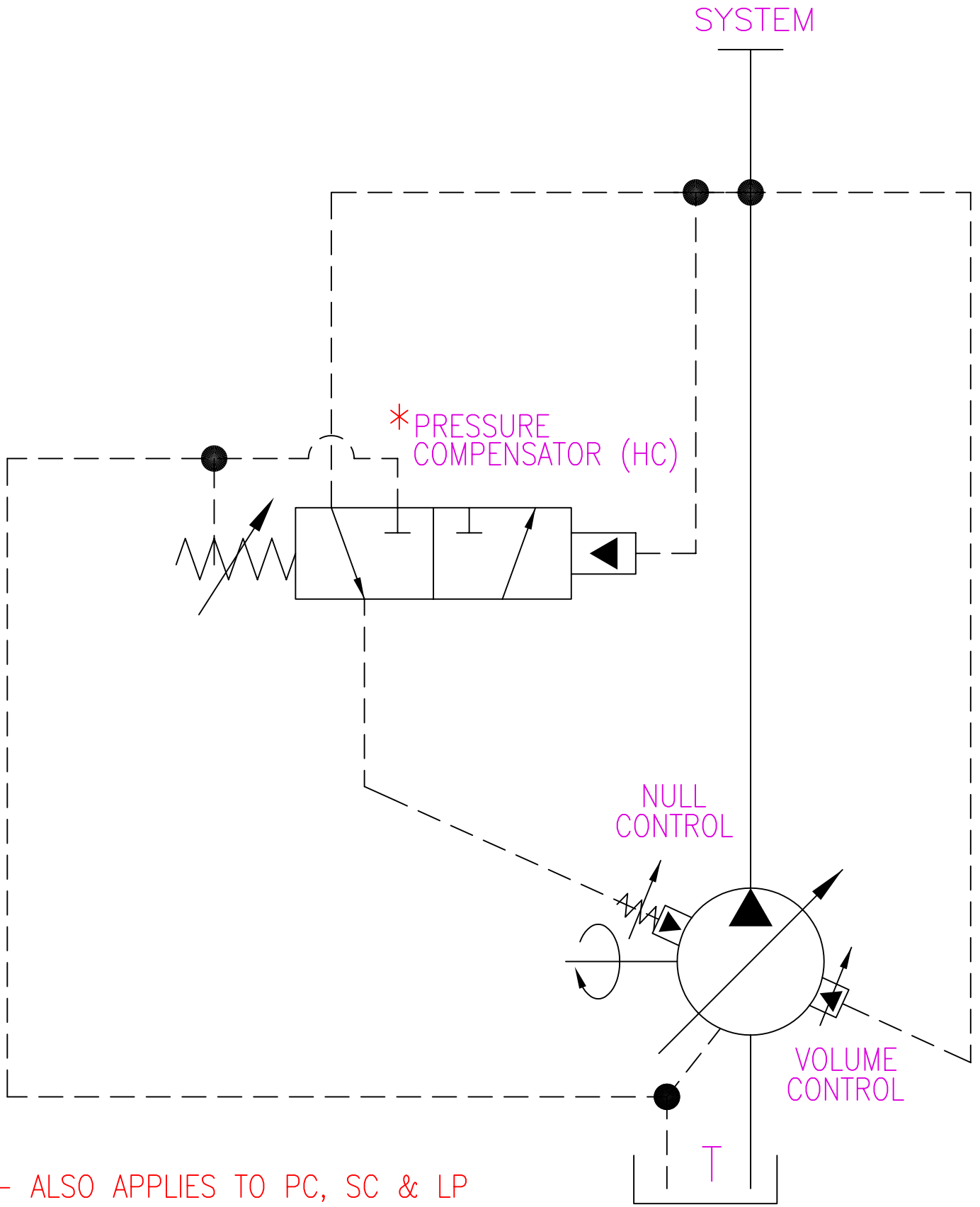

* - ALSO APPLIES TO PC, SC & LP

NOT TO SCALE

THE INFORMATION CONTAINED HEREIN IS THE PROPERTY OF HARTMANN CONTROLS INC., AND IS NOT TO BE USED IN A MANNER DETRIMENTAL TO HARTMANN CONTROLS INC.

DWG: **SCMHC**

TITLE: **HAND-KNOB
ADJUSTED PRESSURE
COMPENSATOR**

HARTMANN
CONTROLS INC.

604 PROGRESS DRIVE
HARTLAND, WI 53029

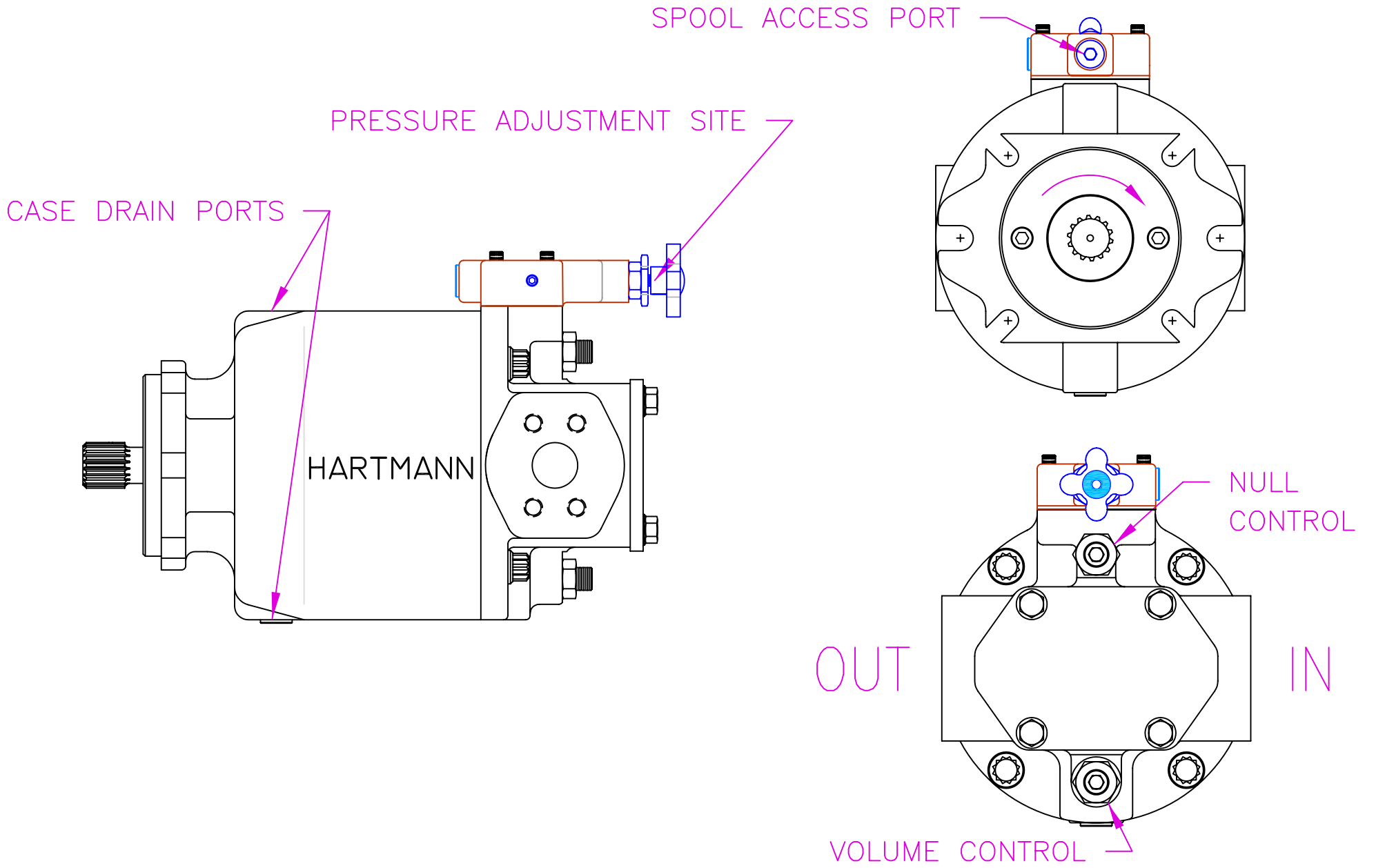

NOT TO SCALE

THE INFORMATION CONTAINED HEREIN IS THE PROPERTY OF HARTMANN CONTROLS INC., AND IS NOT TO BE USED IN A MANNER DETRIMENTAL TO HARTMANN CONTROLS INC.

DWG NO: HCPUMP

TITLE: PVX PUMP WITH A HAND-KNOB ADJUSTED PRESSURE COMPENSATOR



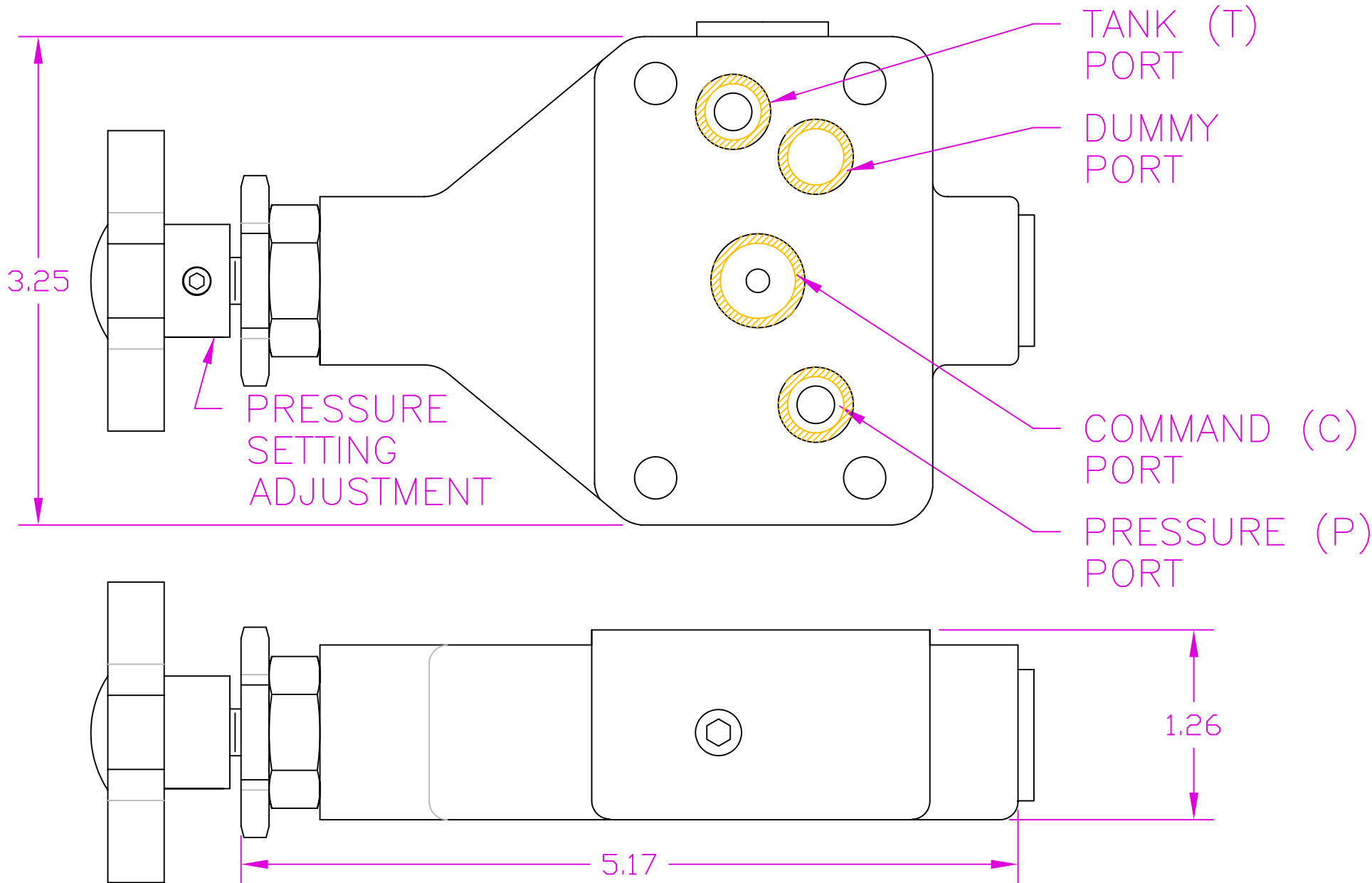

NOT TO SCALE

THE INFORMATION CONTAINED HEREIN IS THE PROPERTY OF HARTMANN CONTROLS INC., AND IS NOT TO BE USED IN A MANNER DETRIMENTAL TO HARTMANN CONTROLS INC.

DWG NO: 52123-2DIM

TITLE: OUTLINE OF A
HAND-KNOB ADJUSTED
PRESSURE COMPENSATOR



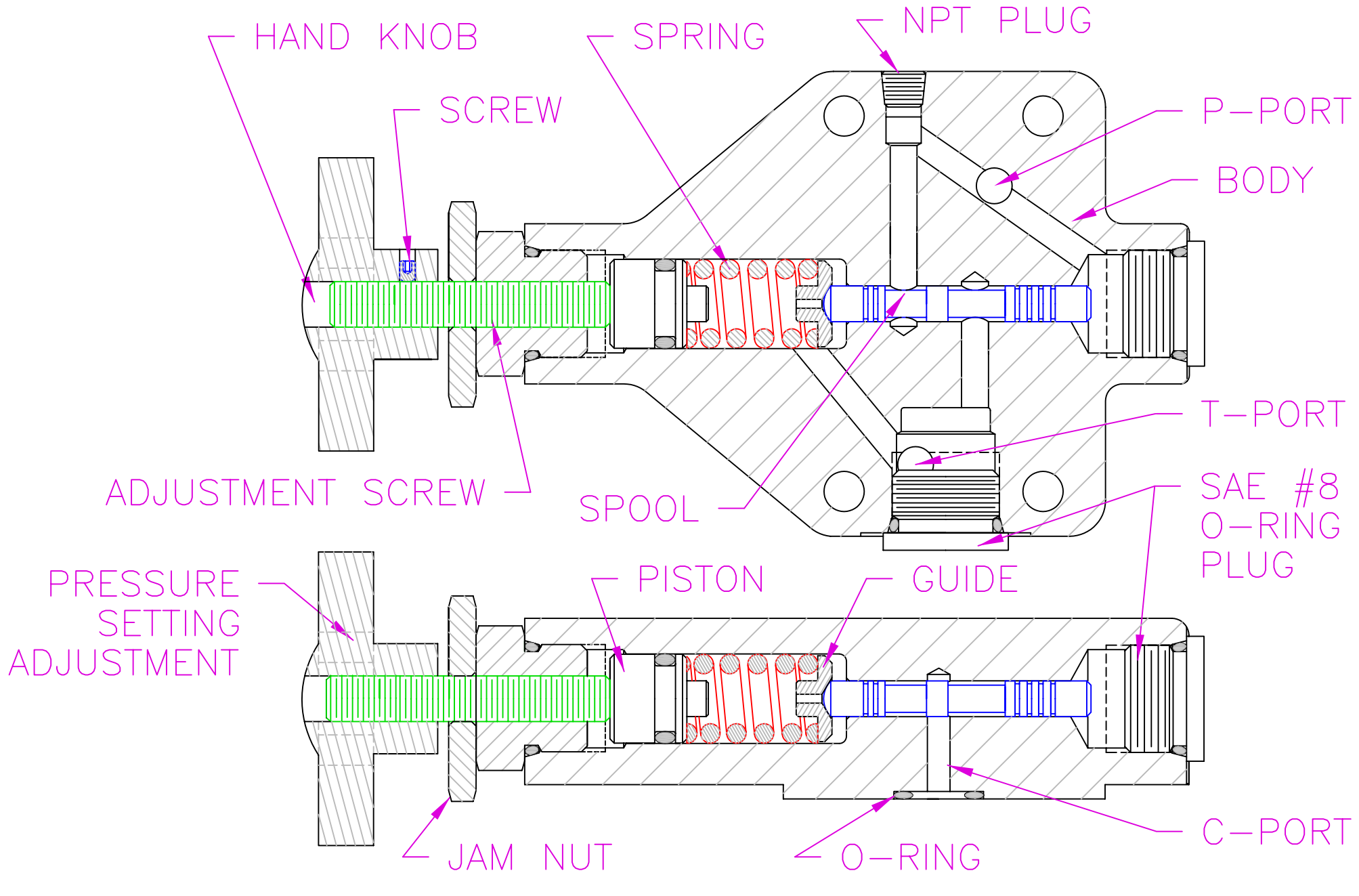

NOT TO SCALE

THE INFORMATION CONTAINED HEREIN IS THE PROPERTY OF HARTMANN CONTROLS INC., AND IS NOT TO BE USED IN A MANNER DETRIMENTAL TO HARTMANN CONTROLS INC.

DWG NO: 52123-2LAY

TITLE: LAYOUT OF A HAND-KNOB ADJUSTED PRESSURE COMPENSATOR

HARTMANN
CONTROLS INC.

604 PROGRESS DRIVE
HARTLAND, WI 53029

**STANDARD PRESSURE-COMPENSATED PERFORMANCE OF A
VARIABLE DISPLACEMENT PISTON PUMP; ISO 32 OIL @ 115° F**

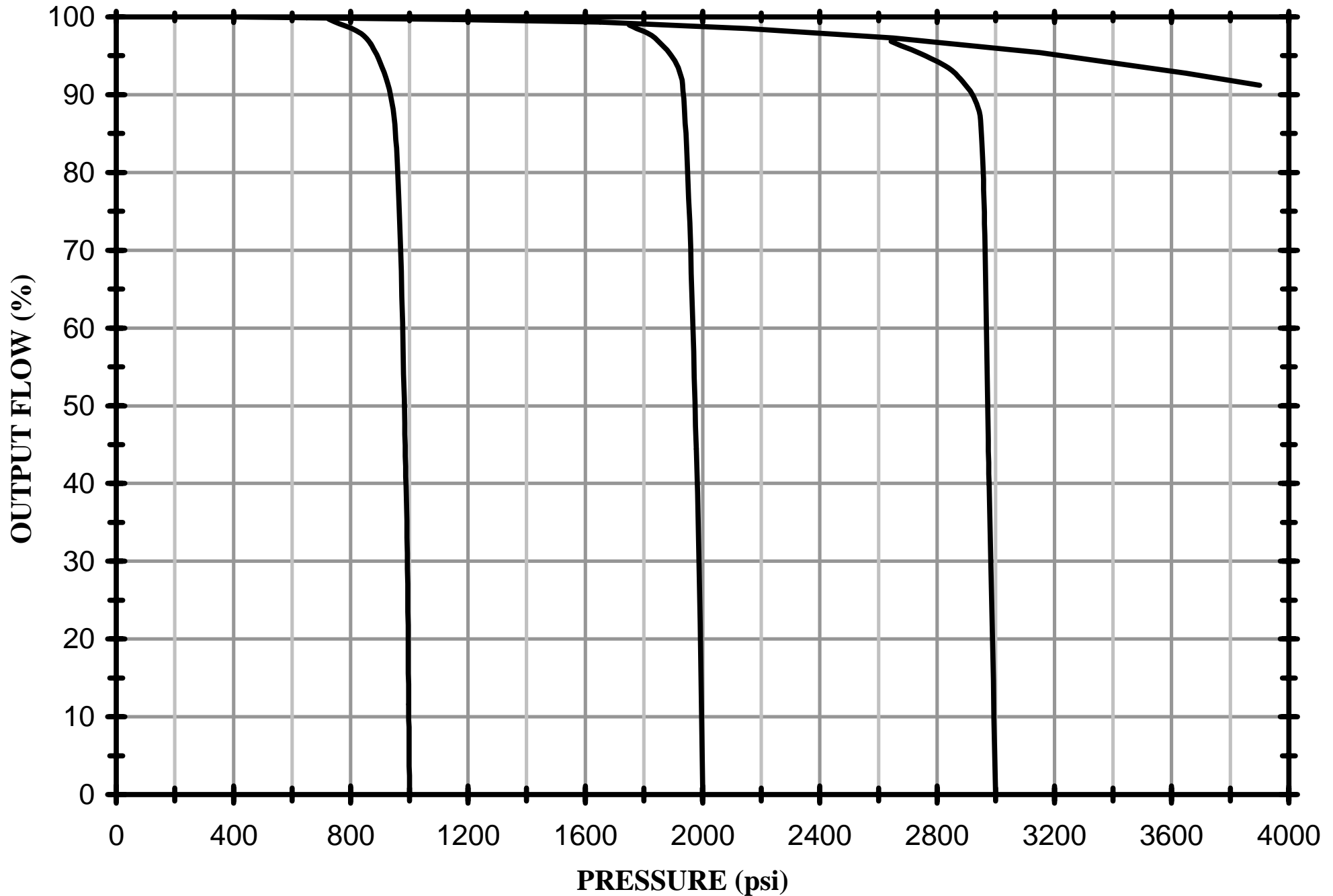

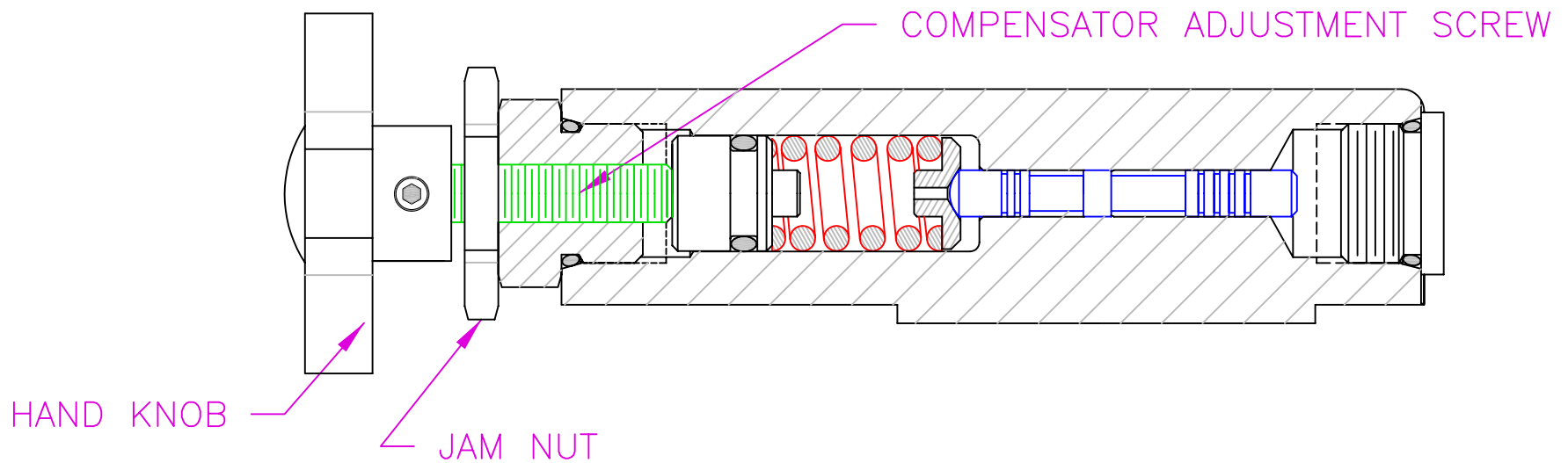

1. HOLDING TIGHT THE HAND KNOB, UNLOCK THE JAM NUT
2. WATCHING THE PRESSURE GAUGE TURN HAND KNOB GENTLY IN INCREMENTS OF LESS THAN 45°:
 - A. CLOCKWISE TURN INCREASES PRESSURE SETTING
 - B. COUNTER-CLOCKWISE TURN DECREASES PRESSURE SETTING
3. WHEN DONE, HOLD HAND KNOB TIGHTLY AND LOCK THE JAM NUT

NOT TO SCALE

THE INFORMATION CONTAINED HEREIN IS THE PROPERTY OF HARTMANN CONTROLS INC., AND IS NOT TO BE USED IN A MANNER DETRIMENTAL TO HARTMANN CONTROLS INC.

DWG NO: 52123-2ADJST

TITLE: PRESSURE ADJUSTMENT
OF A HAND-KNOB SET
PRESSURE COMPENSATOR

HARTMANN
CONTROLS INC.
604 PROGRESS DRIVE
HARTLAND, WI 53029